

WELDING PROCESSES

TIG Technology

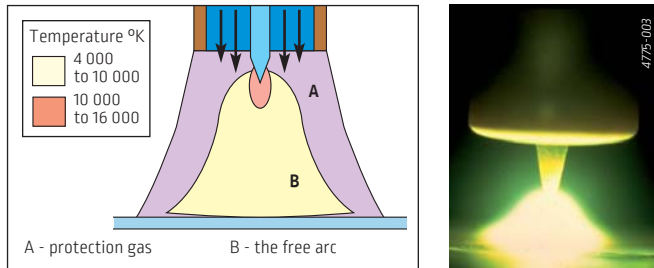

Metals are fused together by heating them with an electric arc. The electric arc is established between a non-consumable (does not melt) tungsten electrode and the workpiece. A filler metal may be used depending on the joint design. The molten metal is shielded from the atmosphere by a stream of inert gas supplied through the torch. The resulting deposited weld metal has the same integrity as the base material. This welding process is used for welding of carbon steel, stainless steel, aluminium, titanium, copper...

The benefits are:

- Good weld bead appearance,
- Aluminium weldability,
- Adapted for fine thickness,
- Welding in all positions.

TOPTIG Technology

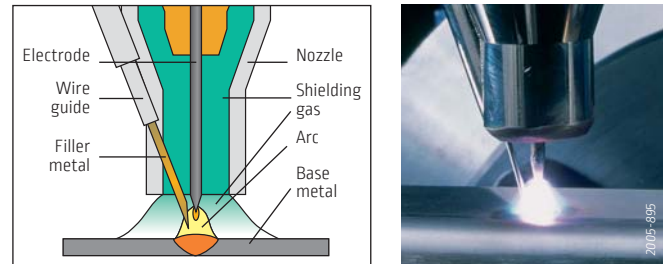

Based on principle of TIG process, an additional filler metal is fed through the nozzle directly into the arc with an angle of 20° to the electrode. This concept guarantees a high deposition rate and an efficient metal transfer. This welding process is used for welding of carbon steel, stainless steel, titanium, inconel, electro-galvanized coated steel (brazing)...

The benefits are:

- TIG high quality welding and guaranteed spatter free,
- Good global productivity,
- Excellent appearance of the weld bead,
- Torch accessibility and welding in all positions.

PLASMA Technology

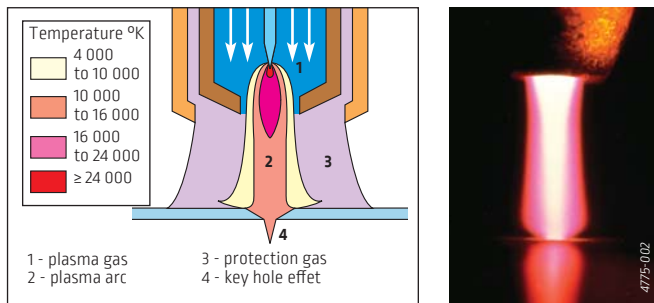

The contribution of energy necessary for welding is ensured by an electric arc in an atmosphere of plasmagene neutral gas. This arc established between an infusible electrode and the parts to be assembled is forced

through a nozzle which constricts it mechanically and pneumatically. This welding process is used for welding of carbon steel, stainless steel, duplex, titanium, Inconel, nickel and alloys...

The benefits are:

- Reduction in the preparation times for assemblies by eliminating bevelling for thicknesses up to 10 mm,
- Joint quality: Complete and regular penetration guaranteed, 100% X-ray quality,
- Reduction of the heat affected zone thanks to the arc concentration,
- Respect of the base material chemical composition,
- Low distortion,
- Reduction or elimination of finishing operations,
- Excellent visual aspect.

MIG/MAG Technology

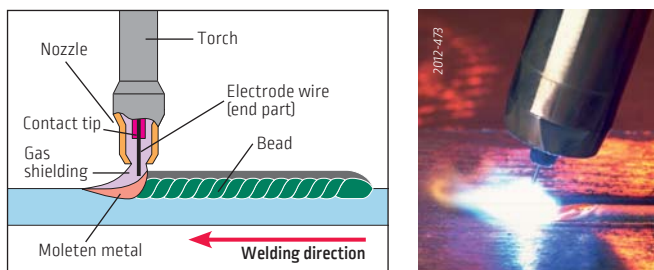

An electric arc forms between a consumable wire electrode and the workpiece (metal) which heats the workpiece metal causing them to fuse. The arc and weld pool are shielded by an inert or active gas. Metal is transferred in the form of drops through the arc towards the workpiece. This welding process is used for welding of carbon steel, stainless steel, aluminium, copper...

The benefits are:

- Easy implementation,
- High welding speed,
- Welding in all positions,
- Low welding investment cost.

SAW Technology

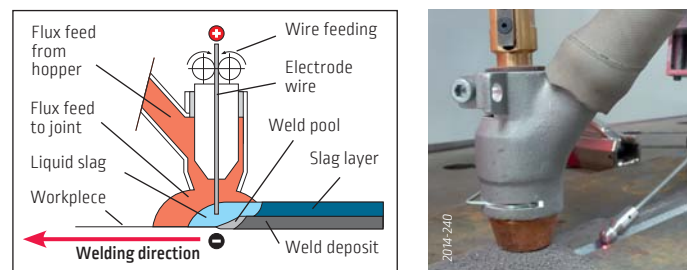

Similar to MIG/MAG welding, SAW involves the formation of an arc between a continuously fed wire electrode. Covering flux is used to generate protective gas and slag protecting the weld metal. The flux can also help donate alloying elements. It is dedicated mainly for flat and fillet welding. This process is generally used for the welding of materials as carbon steel and stainless steel.

The benefits are:

- High deposition rates,
- High penetration,
- Large execution speeds obtained by the use of high currents on one or more electrode-wires,
- Excellent compact joints with good mechanical properties,
- High duty cycle,
- Operator comfort: low fumes and invisible arc.

Lincoln Electric offers a large choice of welding processes through its products.

Several criteria allow to define the best process adapted to the customer application, function of materials, thicknesses, technology, quality and productivity required.

Segments

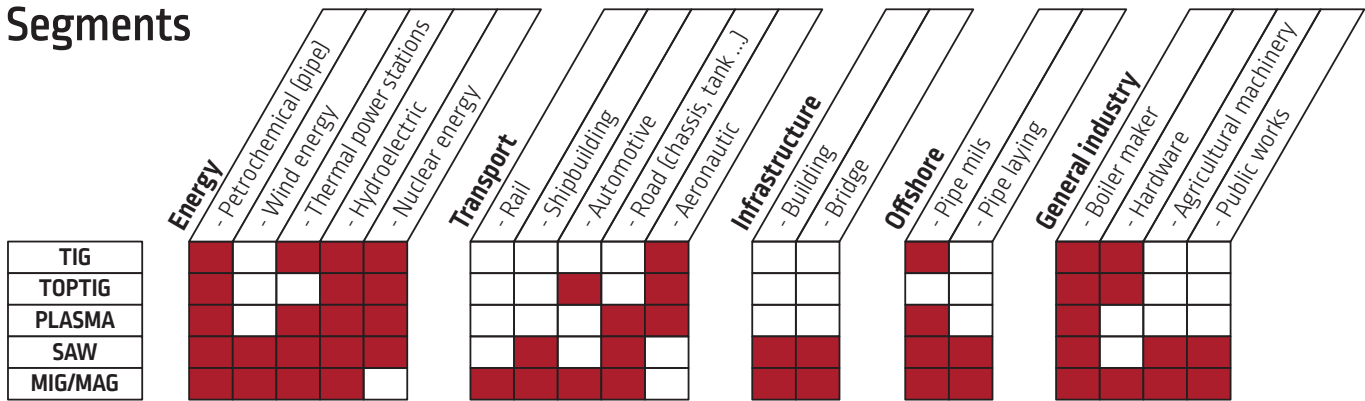

Welding performances

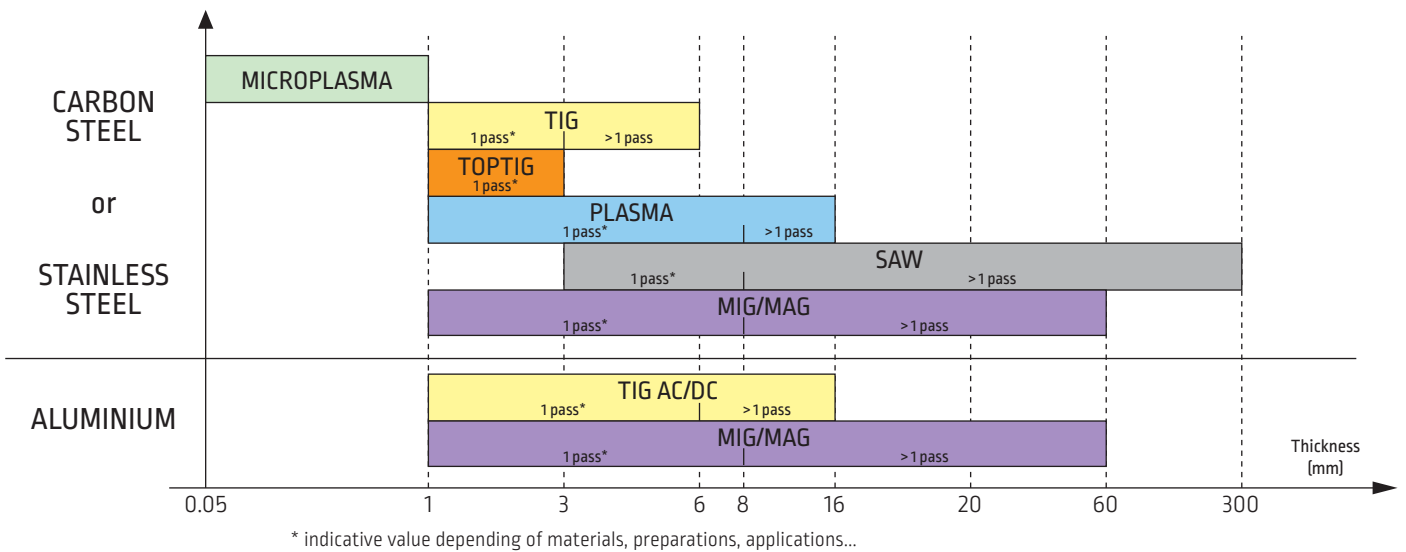

Comparison of the main welding processes

Choice criteria	PROCESSES				
	TIG	TOPTIG	PLASMA	SAW	MIG/MAG
Quality	●	●	●	●	●
Speed	●	●	●	●●	●●
Spatter	●	●	●	●	●
Completion	●	●	●●	●	●
Cost	●	●	●	●	●●

● Excellent
● Good
● Fair

PLASMA / TIG MACHINE RANGE

The Plasma/TIG solutions are often used to weld vessels or pipes in various domains as food, transport, petrochemical or aeronautical industries.

Lincoln Electric proposes a large range of machines adapted and dedicated to each activity sector.



2011-154

Mechanisation machines with TIG or plasma process for automatic welding of pipes or vessels with low diameter.



2000-343

Tricathode installation

for in line pipe welding with high productivity level.



2008-468



2018-482

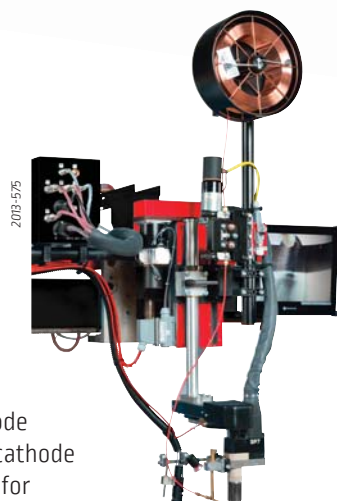

2018-575

Autonomous and multi-purpose welding installation

in monocathode Plasma/TIG version or in bicathode Plasma + TIG configuration for higher productivity.



2010-596



2007-471_ret

CITOTURN lathe with microplasma installation used for high precision welding of thin precious metals.

Plasma/TIG seamer benches

for longitudinal welding of flat sheet metal or large vessels (internal or external welding)

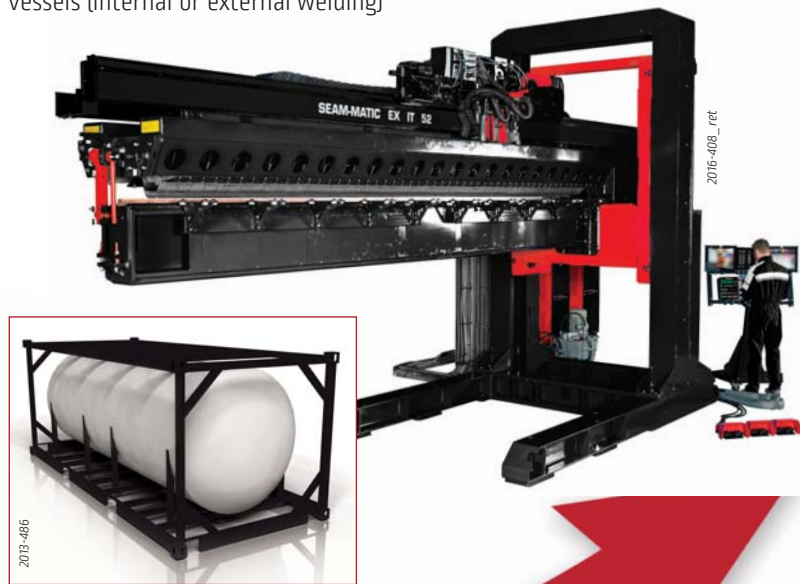

Specific machines

built from standard equipment and adapted to the customer applications

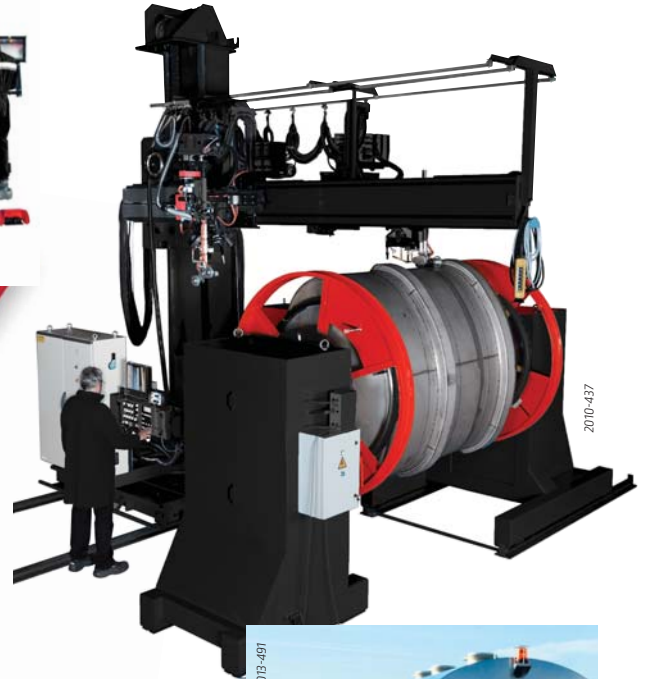

Plasma/TIG column and booms with rotators or turntable for circumferential, cornice, flat or vertical down welding



TIG AND PLASMA INSTALLATION



Applications

Multi-purpose welding installation to enable the following processes to be used in automatic applications:

- DC TIG with smooth or pulsed current,
- AC TIG with variable polarity,
- DC plasma with smooth or pulsed current.

This installation meets the highest quality standards for welding and productivity for industries as diverse as boiler-making using stainless steels, aeronautics using precious metals, chemical engineering, energy production, transformation and transport as well as prefabrication of gas and petrol pipelines etc.

TIG / PLASMA process and performance

The Plasma process is the ideal extension of TIG for thicknesses greater than 3 mm.

It ensures the same level of quality, higher performances and 100% penetration thanks to Key-Hole technology. The diagram shows the different welding performances according to the materials and thicknesses.

Maximum thickness which can be welded in a single pass is reduced for:

- vertical down and cornice (2G) welding positions,
- small diameter and very thick tubes.

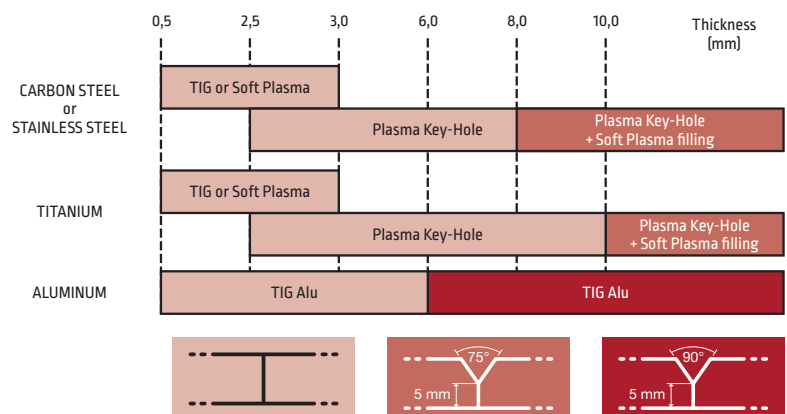

Improvement productivity with PLASMA + TIG Process

The Plasma + TIG process is specially designed for assembling panels for the prefabrication of vessels longer than 4 meters and carrying out circular welds for diameters greater than 2 meters.

This process of using 2 torches in tandem gives a productivity gain of 30-50 % over a single-torch plasma installation.

The "plasma" arc penetrates the butt-jointed panels. The "TIG" arc equipped with filler metal, electromagnetic arc oscillation and a gas trailing shield produces a perfect surface finish which can often be left without any further treatment.

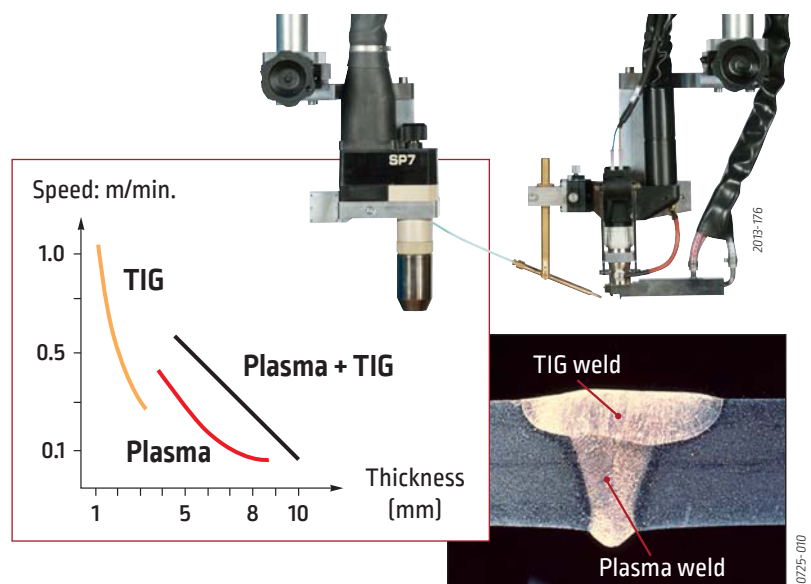

Single torch: PLASMA or TIG

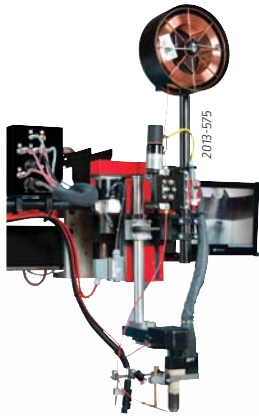

Bi-cathode: PLASMA+TIG

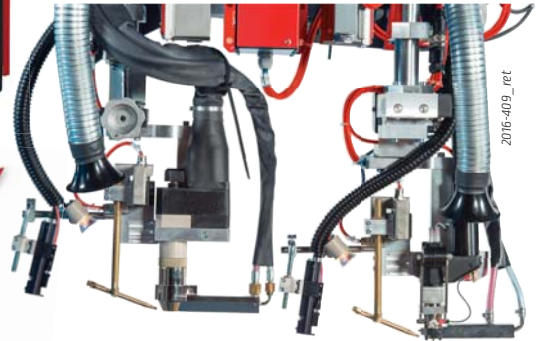

PERFORMANCES

TIG/PLASMA equipment

Lincoln Electric offers two types of control panel.

NERTAMATIC 450 Plus



Tools edit programs
and create WPS

NERTAMATIC 450 Plus integrates the management of the complete welding process controlled from a central panel, robust and easy to use with a clear text LCD screen display of 4 lines of 20 characters which allows:

- Storing of 99 welding programs (voltage, current, wire speed, plasma gas, movement speed, magnetic oscillation...),
- Parameters modification during welding,
- Cycle start/stop, manual control of gas/wire/AVC/ movement,
- Complete management of key hole closure,
- Pulse current settings for thin thickness welding and vertical or cornice welding,
- Easy integration and communication with external PLC thanks to Open PLC function,
- Import/export via USB key for uploading or downloading programs,
- Edition of programs on external computer, thanks to Off-line software.

HPW Advanced



HPW Advanced is a modern industrial PC allowing the global management of the complete welding process and machine axes. Its main characteristics are:

- Large touch screen 19" with a friendly and intuitive interface allowing the programming, controls and follow up,
- Numerical management of the welding process, its associated movements and drive units via industrial PC,
- Traceability, a program integrates all the parameters allowing the repeatability of the welding operation,
- Video monitoring integrated in control screen
- Quality follow-up in option, record and storage of the essential parameters of welding (current, voltage, gas, wire feeding, movement),
- Wireless remote control (option),
- Import/export via USB key for uploading or downloading programs and WPS edition.

Welding



Programming



Configuration



Quality (as a option)



Wireless
remote
control

TIG AND PLASMA EQUIPMENTS

Power source

The power source **NERTAMATIC 450 Plus** centralizes the global management of the welding cycle: the control of the current, the voltage, the wire speed, the gases flow, the magnetic oscillation and the welding speed.

An optional AC module can be integrated to control the current for variable polarity aluminium welding.



	Characteristics
Duty cycle	450 A @ 100%
Pulsed current	1 to 100 Hz
AC current	50 to 200 Hz
Data exchange	USB
Primary power supply	3 x 230 V - 400 V - 415 V - 440 V / 50-60 Hz
Power consumption	22 kVA
Protection class	IP23
Weight and dimensions	270 kg 1200 (h) x 500 (w) x 850 (d) mm

Torches

High performance water cooled torches to ensure quality and stability of the process and its equipments.

Torches are equipped with quick connection systems for easy change and maintenance.

MEC4:

For TIG welding:

- 500 A at 100%,
- standard electrode easy to replace,
- twin HF ignition for better arc striking.

Options:

- gas trailing shield to protect welds of sensitive metals,
- magnetic arc oscillation equipment.

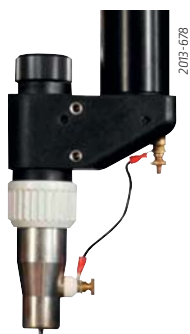

SP7:

This torch is the reference in the market, for soft and key hole plasma welding:

- 450 A at 100%,
- Standard electrode easy to replace and self-aligned,
- Cooled nozzle ensuring long life time of consumables.

Options:

- Gas trailing shield to protect welds of sensitive metals.



PLASMA gas

For thicknesses greater than 2.5 mm, PLASMA welding uses the Key-Hole technique.

If the arc is extinguished instantly, a hole remains in the workpiece.

In order to remedy this disadvantage on circular welding, and in order to make the hole disappear, it is necessary, before extinguishing the arc, to gradually reduce the torch's plasma gas flow simultaneously with the arc current. This made possible with a numerical valve controlling the plasma gas cycle.

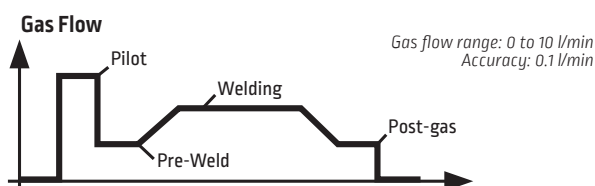

Wire feed device

It is often necessary to feed the molten pool with metal during the welding operation in order to prevent the seam from showing hollows, to supply soft steels with deoxidizing elements and for successive seams.

The system allows to quickly and accurately adjust the wire impact point in the welding pool thanks to micrometer slides.

The adjustment can be manual or motorised for remote control.

	Characteristics
Carbon steel Stainless steel Titanium wires	Ø 0.8 / 1.0 / 1.2 mm
Aluminium wire	Ø 1.2 / 1.6 mm
Max wire speed	6 m/min

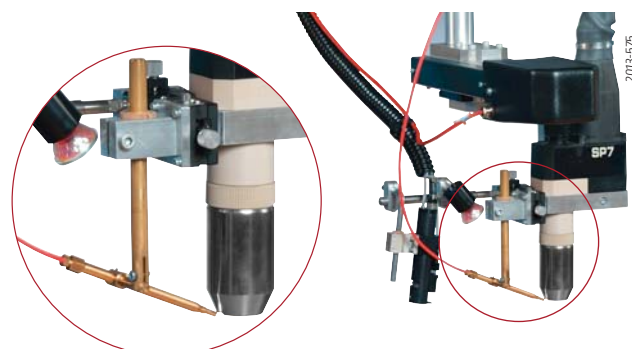

AVC system

A constant distance between the torch and the workpiece is a key of quality to ensure a constant penetration and bead width.

The **Arc Voltage Control (AVC)** keeps this constant distance by automatic regulation of the arc voltage: function fully integrated into the Lincoln Electric system composed of an electrical vertical slide travel 200 mm.

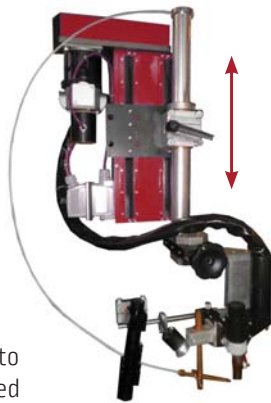

Oscillarc plus

Arc deviation

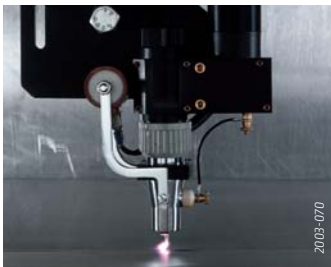

This technique is used to electrically deflect the TIG arc forward in the welding axis, increasing the speed by 30 to 50% for thicknesses of less than 2 mm.

Arc oscillation

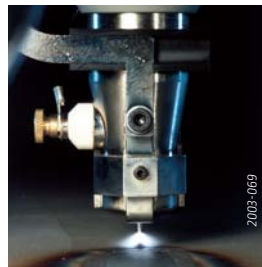

Arc oscillation is used to deposit metal over areas up to 15 mm wide to fill bevels or reconstitute surface coating.

Video camera

The TIG/plasma video system **VISIONARC VA2** can be easily integrated. It uses a greatly enlarged image which enables the precise position of the welding torch to be viewed thus making the operator's work easier and improving the quality of the welding operation.

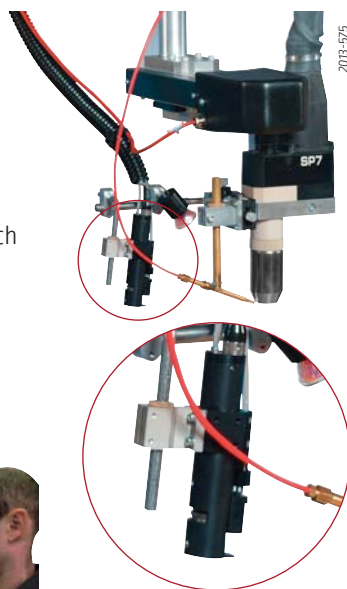

System with large color screen 15", miniaturised camera and additional lighting

Cooling unit

The **FRIOJET 300 W** cooling unit is compact with coolant constant supply, in closed circuit, used to cool down torches.

Water circulation in closed circuit makes it possible:

- To prevent the deposit of boiler scale in conduits and in the torches to be cooled,
- To save water, to have a constant water flow-rate,
- The regulation of water temperature provides a constant production quality and extends significantly useful life of torches and of wearing parts (steady temperature).



Characteristics	
Primary supply *	230 V / 1 ph / 50 or 60 Hz
Nominal water flow rate	0.26 m ³ /h
Nominal water pressure	5.5 bars

* directly supplied by power source
NERTAMATIC 450

Cooling unit equipped with display of temperature and control of return flow plus coolant level.

Hot wire

Productivity improvement by increasing the deposition rate

For filling bevels 40 mm deep, the use of hot wire provides a good solution and is particularly suited to applications where a high specification of the welded joint is required. This special technique uses an auxiliary current to bring the end of the wire to near its melting point.

Viable for plates of thickness 10 mm and above, the use of hot filler wire enables 2.5 to 3 kg of metal to be deposited per hour for filling bevels using multiple passes or for quality hard-surfacing:

- Additional power source for the hot wire current between 60A and 120A,
- No additional wire feed thanks to direct connection on the cold wire system.



WELDING IN LINE PIPE INSTALLATION



Applications

Lincoln Electric proposes solutions for in line pipe welding to be integrated into pipe mills:

- Monocathode installation with MEC4 TIG torch for tube thickness 0.5 to 3 mm,
- Monocathode installation with SP7 plasma torch for tube thickness 2.5 to 8 mm,
- Tricathode installation with E16 torch for tube thickness 0.5 to 1.5 mm,
- Tricathode installation with E25 torch for tube thickness 1 to 3.5 mm,
- Tricathode installation with combination of TIG + PLASMA + TIG torches for tube thickness 2.5 to 8 mm.



*Piping: Chemical, Petrochemical, Nuclear power industry, Boilers and heat exchanger, Off shore, Cryogenic, Shipbuilding, Military and Aeronautic...
Structure: Industrial building, Commercial center...
Ornamental: Door, Windows, General railing, Furniture, Decoration...*

Typical performances

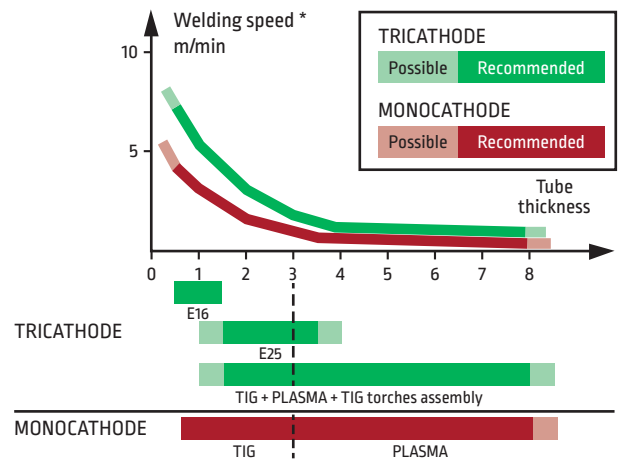

* Welding speeds are indicative and depend on the material, the quality required, and the quality of the pipe mill.



TRICATHODE process

TRICATHODE welding consists of a sequence of three dual-flow TIG processes using a special welding torch. The first arc is fitted with an electromagnetic arc deviation device.

Compared to other welding process used for this type of fabrication, Lincoln Electric's TRICATHODE process is of particular interest in terms of performance flexibility, investment/performance ratio and operating costs.



Tricathode Dualgas flux process:

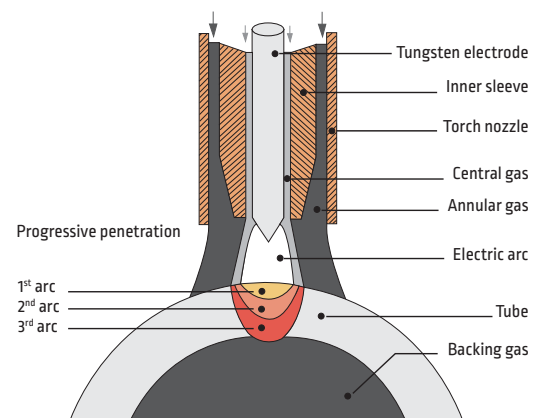

MONOCATHODE MEC4 or SP7 torches



TRICATHODE



TIG + PLASMA + TIG

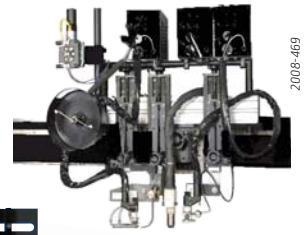

E16 torch

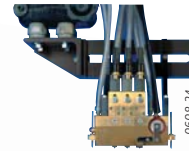

E25 torch



PERFORMANCES

Monocathode MEC4 or SP7

Package dedicated to TIG or plasma process without wire feed device and arc voltage control, the pipe line machine assuring a constant arc height.

Main components of the package:

- Power source 450 A at 100%, smooth current welding,
- MEC4 TIG torch or SP7 plasma torch,
- Remote control, HF starting unit.



SP7 plasma torch

- 450 A at 100%
- Typical application (wall thickness): 2.5 to 8 mm

MEC4 TIG torch

- 500 A at 100%.
- Typical application (wall thickness): 0.5 to 3 mm.



Tricathode

The basic system consists mainly of:

- 3 x power sources NERTAMATIC 450 Plus,
- 450 A each at 100%, smooth or pulsed current welding,
- Control panel with current control, digital voltage and current displays for each arc, adjustment and displays of gas flow setting, adjustment of electromagnetic arc on first electrode,
- Torches interface including HF source,
- Welding head mounting assembly.

E16 torch

- Implements the dual flow tricathode process.
- 200 Amp per electrode (total 600 Amp).
- Independant adjustment of each electrode to the shoe (one piece design).
- Electrode tungsten Ø 2.4 mm and 3.2 mm.
- Typical application (wall thickness): 0.5 to 1.5 mm.

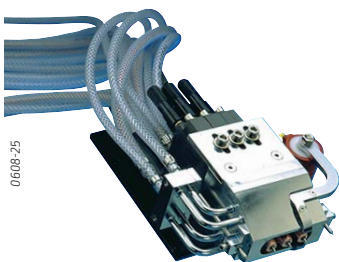

E25 torch

- Implements the dual flow tricathode process.
- 400 Amp per electrode (total 1200 Amp).
- Independant adjustment of each electrode to the shoe (one piece design).
- Electrode tungsten Ø 3.2 and Ø 4 mm.
- Typical application (wall thickness): 1 to 3.5 mm.

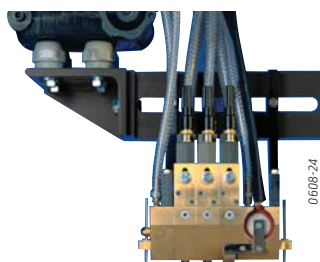

TIG + PLASMA + TIG welding head

- Two MEC4 TIG torches.
- One SP7 plasma torch.
- Independant adjustment on each torch.
- Typical application (wall thickness): 2.5 to 8 mm.

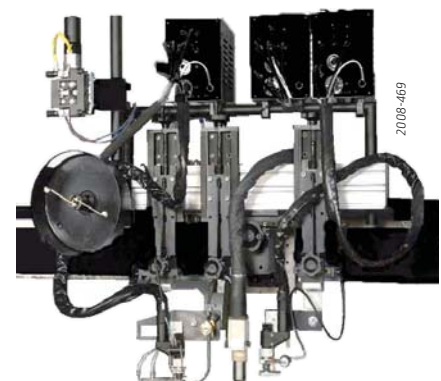

TOPTIG



Applications

TOPTIG process is a major innovation in the world of automatic welding. Developed in the Lincoln Electric research center, **TOPTIG** is a new process development from arc welding classical solutions. This new process can be used effectively on carbon or stainless steel plates up to 3 mm or on galvanized sheets with weld brazing.

The activities sectors are:

- Automotive subcontracting,
- Fine boiler making,
- Metal furniture,
- Aeronautics subcontracting.

Process

TOPTIG allows a better accessibility for welding complex structures. It offers very good performance concerning speed, and quality (spatter free).

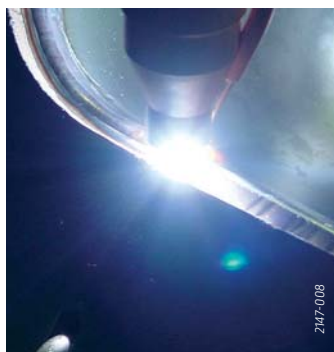

TOPTIG innovative process principle

In TIG automatic welding mode, the filler wire is fed into the weld pool in front of the torch. In the TOPTIG process, the filler wire is fed through the welding nozzle in the area where the temperature is the highest. The wire therefore melts into small droplets exactly as in the MIG process. The use of a pulsed current synchronized with wire gives better control over the welding operation.

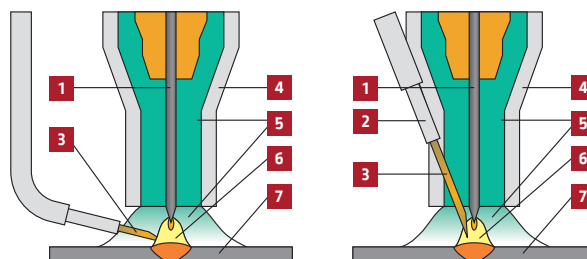

TIG process
 10 000 à 16 000 °K
 4 000 à 10 000 °K

TOPTIG process
 1 - Electrode
 2 - Wire guide
 3 - Filler metal
 4 - Nozzle
 5 - Shielding gas
 6 - Arc
 7 - Base metal

Torch accessibility

Compared with a traditional automatic TIG torch, the compactness of the wire lead-in incorporated into the nozzle gives accessibility at an angle comparable with that obtained using a MIG/MAG torch.

This increases the scope for robotization and extends the range of workpieces which can be welded automatically.

Installation

Lincoln Electric offers two types of **TOPTIG** installation with flat or pulsed current. It can drive a constant or pulsed wire feed which is synchronized with the welding current.

TOPTIG 220DC

TOPTIG 220 DC supplies 220 A at 100% duty cycle. The RC-JOB permits a complete welding cycle to be programmed. Program selection and chaining is carried out by analog signals.



TOPTIG NERTAMATIC 450 PLUS

NERTAMATIC 450 Plus supplies 450 A at 100% duty cycle. The console permits a complete welding cycle to be programmed. Program selection is carried out by binary code, and program chaining by pulse. Torch capacity limited to 350 A at 100% using a water cooled nozzle.



MICROPLASMA



Manual and automatic welding applications

For the manual or automatic assembly of thin precious metals in the thickness range: 0.05 - 1.0 mm (stainless steels, Inconel, titanium, silver and gold alloys). For the electric and electronics components industries, small containers, metal filters and tool repairs as well as sectors of the horology, goldsmith and medical industries.

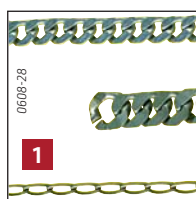

1 - Jewellery

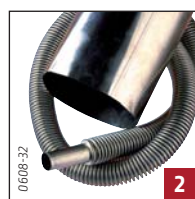

2 - Fine sheet metal work



3 - Small containers



4 - Filters

Installation

PLASMAFIX 51 Characteristics:

- User friendly front panel,
- Multilingual display,
- Programmable welding cycles,
- 100 programs memory,
- Configuration adapted to the user's needs,
- Program print out,
- Also for TIG welding,
- Equipped of RS 232 for coupling a P.C or printer,
- Cooling by a liquid,
- Tungsten electrodes: \varnothing 1.0 or 1.6 mm, 75 or 150 mm long.

Installation with cooling unit on trolley



Torches

Two types of torch for use in manual or automatic mode:



SP45 automatic



SP45 manual

An SP20 manual or automatic torch can be supplied. This weights considerably less and has a maximum current rating of 20 A at 100%.

Options

- **Welding lathes**
Precision circumferential machine for microplasma and TIG welding.



- **Double welding command pedal**
(replaces the torch's trigger)

- **Torch maintenance box with set of wear parts**



- **Trigger and current adjustment pedal**

- **Trolley**

Able to receive the PLASMAFIX 51 power source, the cooling unit and two gas bottles.

Plasma / TIG machines

The Plasma/TIG applications are multiple and varied, here some examples of machines which answer to the main customer needs.

Assembly of flat sheet metal and closure of vessel sections

Seamer bench for longitudinal welding.

The vessel is welded by plasma/TIG or plasma + TIG process inside the INTER seamer bench.

The operator can see the joint and adjust the position of the torch thanks to a video camera device.

In/Out feed tables for material handling to aid production.

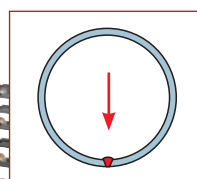
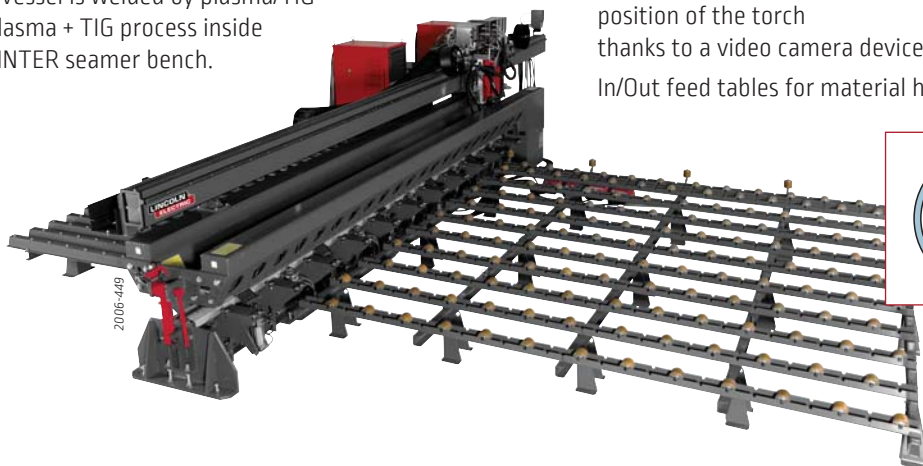

Assembly of vessels by conventional technique

Column and boom with rotators for circumferential welding.

To assemble 2 vessels, it's possible to put them on rotators and the plasma column and boom carries out the circumferential welding.

Safety and operator comfort are guaranteed thanks to the control of the welding operation from the ground.

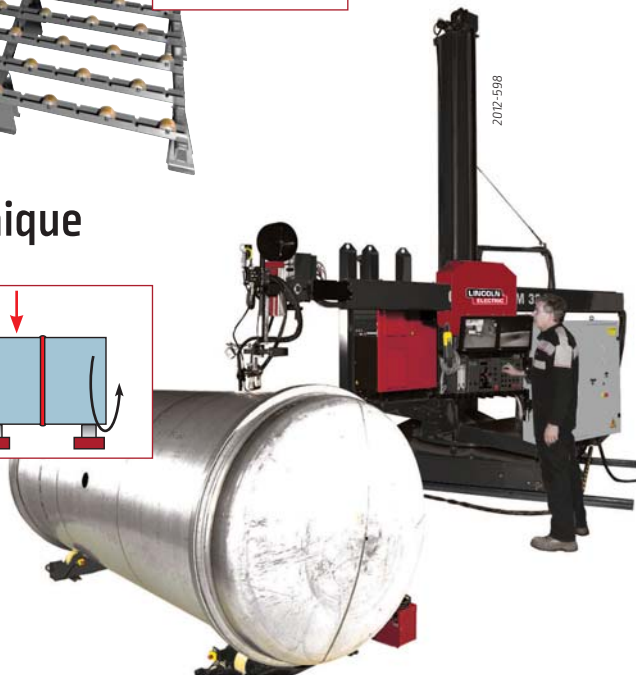
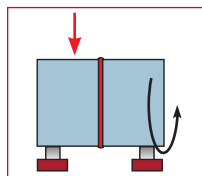

Assembly of vessels in vertical position

This technique is used mainly for large diameter vessels or products whose rigidity is low (ratio diameter, thickness, dimension).

The vertical assembly facilitates the handling of workpieces and reduce tooling needed.

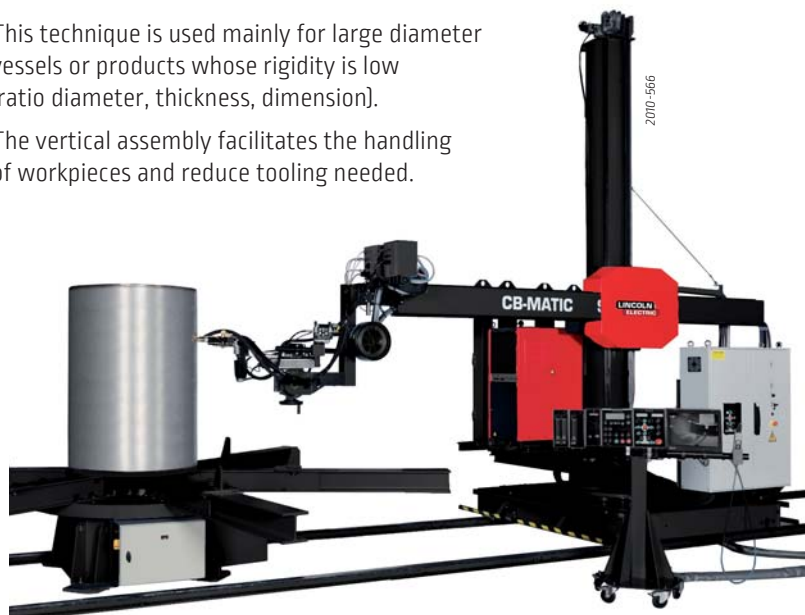

Column and boom with turntable for longitudinal and circumferential welding:

- Longitudinal in vertical down position,
- Circumferential in cornice position.

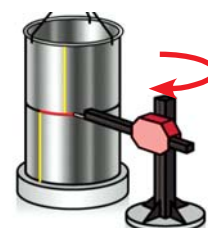

Pipe prefabrication assembly

Mechanisation machine with plasma process and HPW control to weld pipes with elbows and flanges.

The work piece is positioned on the X-rotators and the motorised headstock carries out the rotation.



Elliptical tank

The plasma torch movement is controlled by the column and boom.

The Headstock HLM+F allows the rotation of the tank and ensures a high flexibility for the mounting and the holding of the piece.



Pipe production fully automated process

Complete welding system with:

- Column and boom equipped with plasma + TIG process for external longitudinal and circular welding.
- Fixed internal boom equipped with TIG head for internal remelting.
- Pipe holding device with rotators on carriages to turn and move the pipe.

